

VALVOLE DI COMPLEMENTO PER CIRCUITI PNEUMATICI

*Complementary valves
for pneumatic circuit*



FLUIDO SISTEM S.r.l.

Via Nicomede Bianchi, 61/3 - 10146 TORINO (Italy)
Tel. +39 011.797.322 - 011.797.420 / Fax +39 011.797.412
E-mail: fluidosistem@mclink.it - Web: www.fluidosistem.it

VALVOLE DI COMPLEMENTO PER CIRCUITI PNEUMATICI

COMPLEMENTARY VALVES FOR PNEUMATIC CIRCUIT

VALVOLE DI BLOCCO BIDIREZIONALI

BLOCKING VALVES 2-WAY IN-LINE

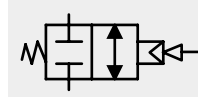

ESEMPI D'APPLICAZIONE - APPLICATION EXAMPLES

NOTE TECNICHE

La servovalvola può essere utilizzata come valvola a 2 vie con pilotaggio pneumatico; vengono esaltate le sue caratteristiche di grande portata e velocità di commutazione.

TECHNICAL NOTES

The blocking valve can be used as a pneumatic 2-way pilot valve to make the most of its great flow rate and switching speed.

FUNZIONI - FUNCTION

VALVOLA A 2 VIE DI GRANDE PORTATA
LARGE FLOW-RATE 2-WAY VALVE

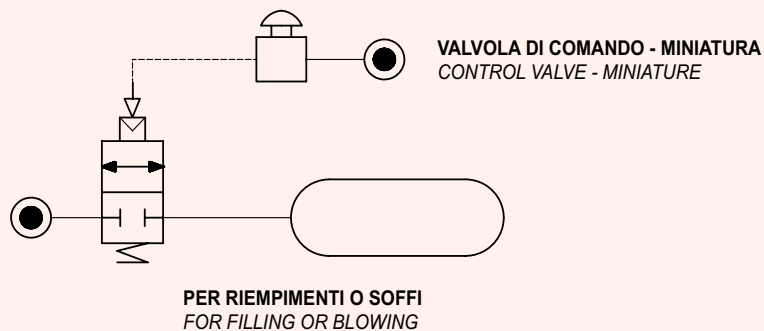

EMERGENZA: BLOCCO PISTONI

EMERGENCY: PISTONS LOCKED

La servovalvola montata sui cilindri assicura il blocco del pistone chiudendo simultaneamente l'alimentazione e lo scarico. Utilizzate su impianti automatici basta una piccola elettrovalvola o un comando solo pneumatico per effettuare l'apertura. L'impianto funziona normalmente. Se un segnale d'emergenza toglie il pilotaggio, i cilindri si bloccano immediatamente nella posizione in cui si trovano.

N.B.: Quando la pressione nell'impianto scende sotto il valore minimo di pilotaggio le valvole si chiudono.

A blocking valve fitted in pair to the cylinders ensure piston stop by shutting supply and discharge at the same time. On automatic systems, a small solenoid valve or a mere pneumatic control, will suffice to actuate opening. The system operates normally. If an emergency signal inhibits pilot, the cylinders will stop immediately at any position they are that time.
Note: When circuit pressure drops below minimum pilot pressure, valves shut.

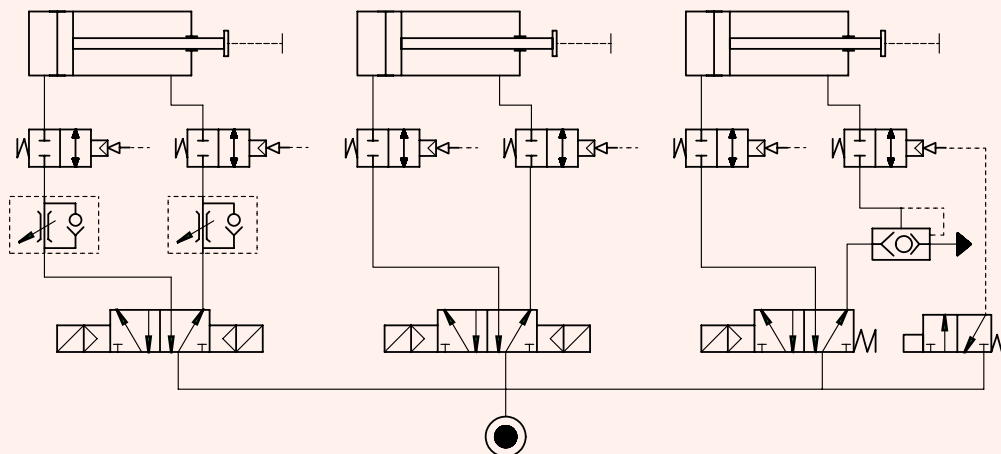

VALVOLE DI COMPLEMENTO PER CIRCUITI PNEUMATICI

COMPLEMENTARY VALVES FOR PNEUMATIC CIRCUIT

SERIE

61-62-63

VALVOLA DI BLOCCO BIDIREZIONALE
2-WAY IN-LINE BLOCKING VALVE

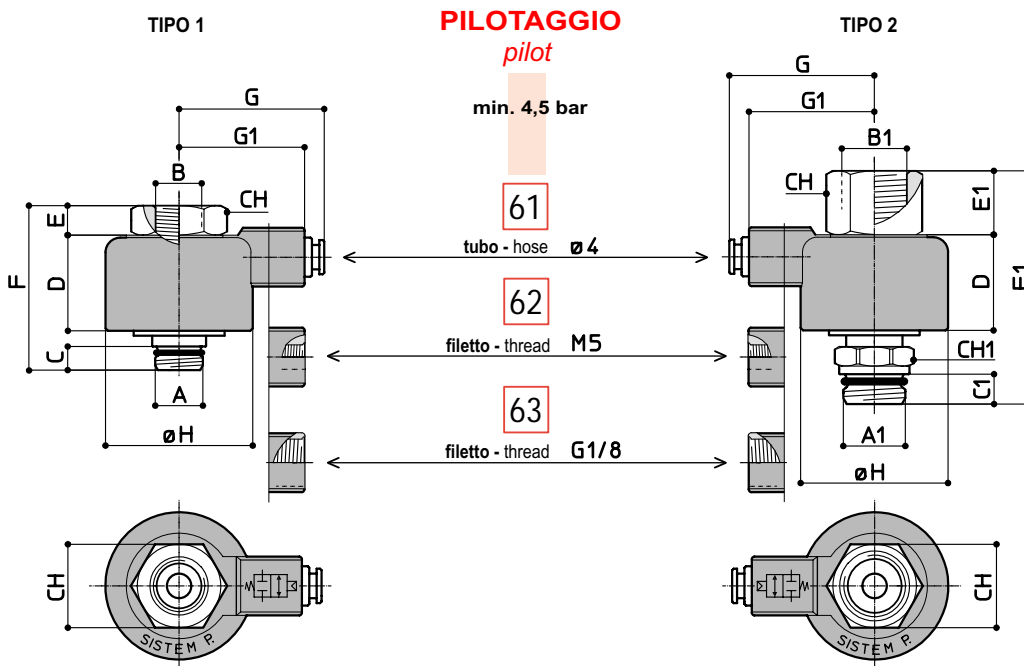
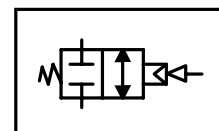

Dati sul passaggio aria
Flow rates data

	CODICE	A	A1	B	B1	C	C1	D	E	E1	F	F1	G	G1	H	CH	CH1	Gr	Ø	mm ²
--	--------	---	----	---	----	---	----	---	---	----	---	----	---	----	---	----	-----	----	---	-----------------

Versione pilotaggio con innesto rapido per tubo ø 4, corpo in nylon / Version with piloting ø 4, nylon main body

Tipo 1	618800	1/8"	-	1/8"	-	6	-	20,5	5,5	-	35	-	29	-	30	17	-	48	5	19,6
Tipo 2	614401	-	1/4"	-	1/4"	-	6	20,5	-	13,5	-	43	-	26	30	-	14	64	5	19,6

Tipo 1	614400	1/4"	-	1/4"	-	7	-	25,5	5,5	-	42,5	-	32,5	-	37	22	-	80	7,5	44,2
Tipo 2	613301	-	3/8"	-	3/8"	-	7,5	25,5	-	13,5	-	54	-	29	37	-	18	108	7,5	44,2

Tipo 1	613300	3/8"	-	3/8"	-	7,5	-	32,5	6	-	51	-	46	-	46	30	-	258	9	63,6
Tipo 2	612201	-	1/2"	-	1/2"	-	9	32,5	-	14	-	60,5	-	32	46	-	22	305	9	63,6

Versione pilotaggio con filetto femmina M5, corpo in metallo / Version with piloting M5, metal main body

Tipo 1	628800	1/8"	-	1/8"	-	6	-	20,5	5,5	-	35	-	-	26	30	17	-	90	5	19,6
Tipo 2	624401	-	1/4"	-	1/4"	-	6	20,5	-	13,5	-	43	-	26	30	-	14	98	5	19,6

Tipo 1	624400	1/4"	-	1/4"	-	7	-	25,5	5,5	-	42,5	-	-	29	37	22	-	127	7,5	44,2
Tipo 2	623301	-	3/8"	-	3/8"	-	7,5	25,5	-	13,5	-	54	-	29	37	-	18	152	7,5	44,2

Tipo 1	623300	3/8"	-	3/8"	-	7,5	-	32,5	6	-	51	-	-	32	46	30	-	253	9	63,6
Tipo 2	622201	-	1/2"	-	1/2"	-	9	32,5	-	14	-	60,5	-	32	46	-	22	299	9	63,6

Versione pilotaggio con filetto femmina 1/8", corpo in metallo / Version with piloting 1/8", metal main body

Tipo 1	638800	1/8"	-	1/8"	-	6	-	20,5	5,5	-	35	-	-	26	30	17	-	90	5	19,6
Tipo 2	634401	-	1/4"	-	1/4"	-	6	20,5	-	13,5	-	43	-	26	30	-	14	98	5	19,6

Tipo 1	634400	1/4"	-	1/4"	-	7	-	25,5	5,5	-	42,5	-	-	29	37	22	-	127	7,5	44,2
Tipo 2	633301	-	3/8"	-	3/8"	-	7,5	25,5	-	13,5	-	54	-	29	37	-	18	152	7,5	44,2

Tipo 1	633300	3/8"	-	3/8"	-	7,5	-	32,5	6	-	51	-	-	32	46	30	-	253	9	63,6
Tipo 2	632201	-	1/2"	-	1/2"	-	9	32,5	-	14	-	60,5	-	32	46	-	22	299	9	63,6

VALVOLE DI COMPLEMENTO PER CIRCUITI PNEUMATICI

COMPLEMENTARY VALVES FOR PNEUMATIC CIRCUIT

VALVOLE DI BLOCCO UNIDIREZIONALI

BLOCKING VALVES 1-WAY IN-LINE

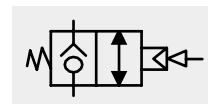

ESEMPI D'APPLICAZIONE - APPLICATION EXAMPLES

NOTE TECNICHE

Comando cilindro pneumatico doppio effetto con valvole a 3 vie, realizzando la funzione centri chiusi, bloccaggi intermedi sulla corsa con i seguenti vantaggi:

- uso di valvole ad otturatore (molto veloci)
- arresto immediato facilitato dalla installazione delle valvole direttamente a bordo.

TECHNICAL NOTES

Double-acting pneumatic cylinder control via 3-way valve. Actuates closed-centers operation. Intermediate stops along travel offer the following advantages:

- use of valves with shutter (very fast)
- check valves fitted direct to cylinder facilitate immediate stop.

FUNZIONI - FUNCTION

TRE POSIZIONI CENTRI CHIUSI - FRAZIONAMENTO CORSA
THREE POSITIONS CLOSED CENTERS - TRAVEL DIVISION

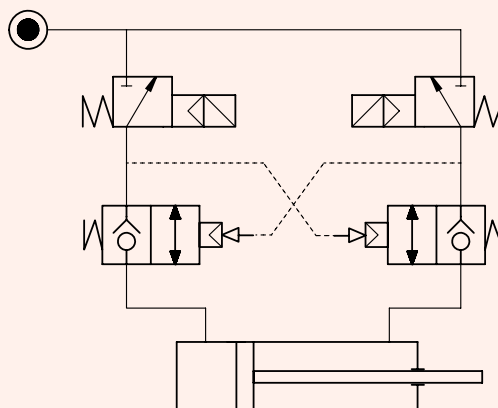

NOTE TECNICHE

Cali improvvisi di pressione, rottura accidentale di tubazioni o di componenti, non pregiudicano la funzionalità.

TECHNICAL NOTES

Any sudden pressure drops, accidental hose breaking or component failure do not affect operation and safety.

FUNZIONI - FUNCTION

MORSA, PRESSORE, BLOCCAGGIO IN GENERE
CHUCK, PRESSER, CLAMPING AT LARGE

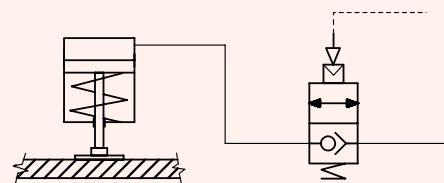

NOTE TECNICHE

Il carico viene mantenuto in posizione contro cali improvvisi di pressione, rotture di tubazioni o di componenti.

TECHNICAL NOTES

Load is kept in place even in the event of sudden pressure drops or accidental breaking of hoses or components.

FUNZIONI - FUNCTION

SOSTENTAMENTO CARICHI (NON DI SICUREZZA)
LOAD SUPPORT (NOT-SAFETY)

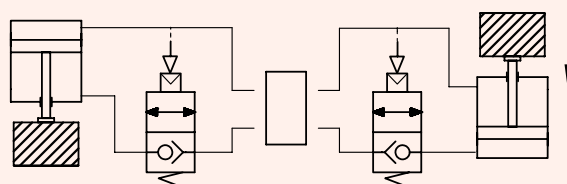

VALVOLE DI COMPLEMENTO PER CIRCUITI PNEUMATICI

COMPLEMENTARY VALVES FOR PNEUMATIC CIRCUIT

SERIE

71-72-73

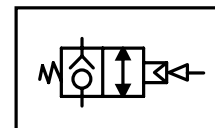

VALVOLA DI BLOCCO UNIDIREZIONALE
1-WAY IN-LINE BLOCKING VALVE

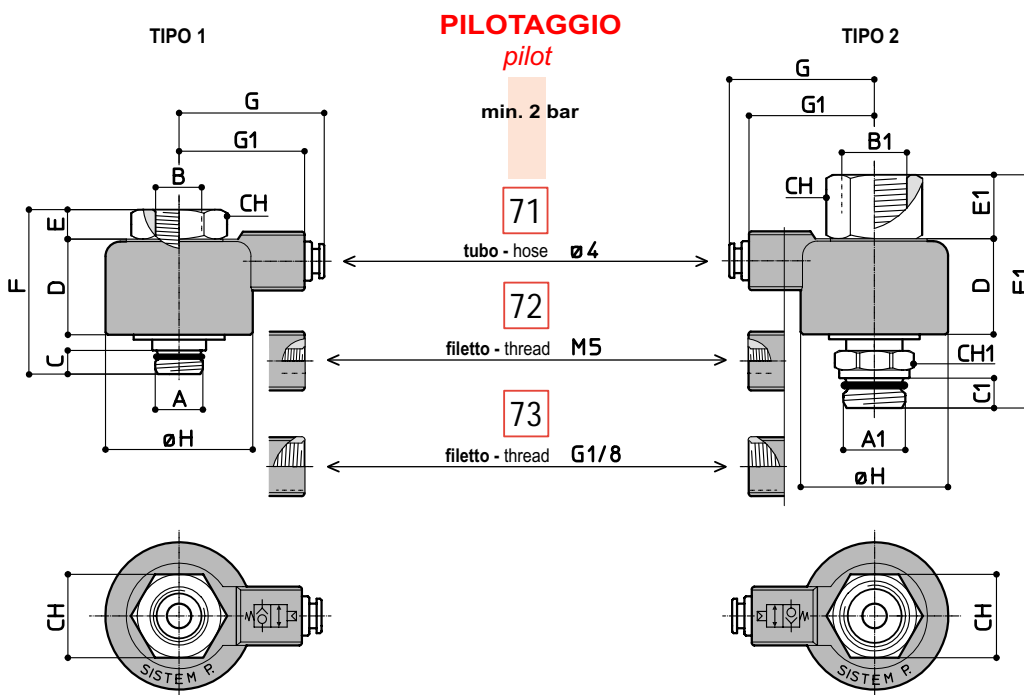

Dati sul passaggio aria
Flow rates data

	CODICE	A	A1	B	B1	C	C1	D	E	E1	F	F1	G	G1	H	CH	CH1	Gr	Ø	mm ²
Versione pilotaggio con innesto rapido per tubo ø 4, corpo in nylon / Version with piloting ø 4, nylon main body																				
Tipo 1	718800	1/8"	-	1/8"	-	6	-	20,5	5,5	-	35	-	29	-	30	17	-	48	5	19,6
Tipo 2	714401	-	1/4"	-	1/4"	-	6	20,5	-	13,5	-	43	-	26	30	-	14	64	5	19,6
Tipo 1	714400	1/4"	-	1/4"	-	7	-	25,5	5,5	-	42,5	-	32,5	-	37	22	-	80	7,5	44,2
Tipo 2	713301	-	3/8"	-	3/8"	-	7,5	25,5	-	13,5	-	54	-	29	37	-	18	108	7,5	44,2
Tipo 1	713300	3/8"	-	3/8"	-	7,5	-	32,5	6	-	51	-	46	-	46	30	-	258	9	63,6
Tipo 2	712201	-	1/2"	-	1/2"	-	9	32,5	-	14	-	60,5	-	32	46	-	22	305	9	63,6
Versione pilotaggio con filetto femmina M5, corpo in metallo / Version with piloting M5, metal main body																				
Tipo 1	728800	1/8"	-	1/8"	-	6	-	20,5	5,5	-	35	-	-	26	30	17	-	90	5	19,6
Tipo 2	724401	-	1/4"	-	1/4"	-	6	20,5	-	13,5	-	43	-	26	30	-	14	98	5	19,6
Tipo 1	724400	1/4"	-	1/4"	-	7	-	25,5	5,5	-	42,5	-	-	29	37	22	-	127	7,5	44,2
Tipo 2	723301	-	3/8"	-	3/8"	-	7,5	25,5	-	13,5	-	54	-	29	37	-	18	152	7,5	44,2
Tipo 1	723300	3/8"	-	3/8"	-	7,5	-	32,5	6	-	51	-	-	32	46	30	-	253	9	63,6
Tipo 2	722201	-	1/2"	-	1/2"	-	9	32,5	-	14	-	60,5	-	32	46	-	22	299	9	63,6
Versione pilotaggio con filetto femmina 1/8", corpo in metallo / Version with piloting 1/8", metal main body																				
Tipo 1	738800	1/8"	-	1/8"	-	6	-	20,5	5,5	-	35	-	-	26	30	17	-	90	5	19,6
Tipo 2	734401	-	1/4"	-	1/4"	-	6	20,5	-	13,5	-	43	-	26	30	-	14	98	5	19,6
Tipo 1	734400	1/4"	-	1/4"	-	7	-	25,5	5,5	-	42,5	-	-	29	37	22	-	127	7,5	44,2
Tipo 2	733301	-	3/8"	-	3/8"	-	7,5	25,5	-	13,5	-	54	-	29	37	-	18	152	7,5	44,2
Tipo 1	733300	3/8"	-	3/8"	-	7,5	-	32,5	6	-	51	-	-	32	46	30	-	253	9	63,6
Tipo 2	732201	-	1/2"	-	1/2"	-	9	32,5	-	14	-	60,5	-	32	46	-	22	299	9	63,6

VALVOLE DI COMPLEMENTO PER CIRCUITI PNEUMATICI COMPLEMENTARY VALVES FOR PNEUMATIC CIRCUIT

VALVOLE DI BLOCCO - *Blocking valves*

CARATTERISTICHE TECNICHE:

MATERIALI DI COSTRUZIONE:
OTTONE (EN 12164-CW614N) NICHELATO
ZAMA-15 (UNI 3717) NICHELATA
NYLON
GUARNIZIONI IN GOMMA ANTIOLIO NBR
PRESSIONE MAX D'ESERCIZIO: 10 BAR (1 MPa)
TEMPERATURA DI LAVORO: -10C (263°K), +80C (353°K)

TECHNICAL FEATURES:

MATERIALS OF CONSTRUCTION:
NICKEL-PLATED BRASS (EN 12164-CW614N)
NICKEL-PLATED ZAMA-15 (UNI 3717)
NYLON
OIL-PROOF RUBBER PACKINGS NBR
MAX WORKING PRESSURE: 10 BAR (1 MPa)
WORKING TEMPERATURE: -10C (263°K), +80C (353°K)

ORIENTABILITA' LIBERA SU 360°
SWIVELING OVER 360°



Le SERVOVALVOLE hanno le connessioni filettate e consentono il montaggio di regolatori di flusso o scarichi rapidi.

BLOCKING VALVES have threaded connections and can mount flow regulators or quick-dump outlets.

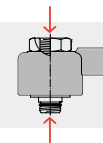

VALVOLA DI BLOCCO BIDIREZIONALE BLOCKING VALVE 2-WAY IN-LINE

FILETTO CILINDRICO FEMMINA UNI-ISO 228/1
FEMALE CYLINDRICAL THREAD UNI-ISO 228/1

CORPO PRINCIPALE (Ottone)
MAIN BODY (Brass)

CORPO ESTERNO (Zama-15 o Nylon)
OUTER BODY (Zama-15 or Nylon)

GUARNIZIONI NBR ESENTI DA SILICONE
SILICONE-FREE NBR O-RING

FILETTO CILINDRICO CON O-RING UNI-ISO 228/1
PARALLEL THREAD WITH O-RING UNI-ISO 228/1

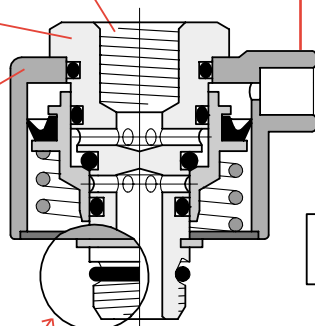
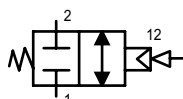

VALVOLA DI BLOCCO UNIDIREZIONALE BLOCKING VALVE 1-WAY IN-LINE

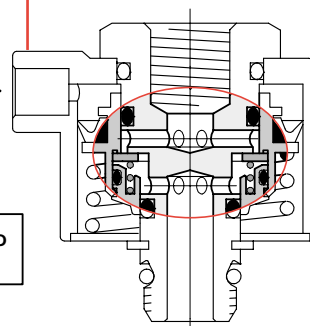
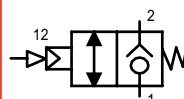

PILOTAGGIO
pilot

tubo - hose $\varnothing 4$

filetto - thread M5 UNI 5542-65

filetto - thread G1/8 UNI-ISO 228/1

SERRAGGIO SERVOVALVOLA

fino a tenuta filetto con o-ring
BLOCKING VALVE TIGHTENING
for O-ring thread proper sealing

1/8" = 2 Nm
1/4" - 3/8" = 4 Nm



TIPI DI TUBO INNESTABILI TUBES D'ACCOUPLMENT

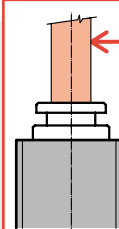

POLIURETANO
POLIAMMIDE (RILSAN PA11/12)
POLIETILENE
POLIESTERE
TEFLON
NYLON (PA6)

VALVOLE DI COMPLEMENTO PER CIRCUITI PNEUMATICI

COMPLEMENTARY VALVES FOR PNEUMATIC CIRCUIT

PRESSIONE MINIMA DI PILOTAGGIO IN FUNZIONE DELLA PRESSIONE D'ESERCIZIO

MIN. PILOT PRESSURE ACCORDING TO WORKING PRESSURE

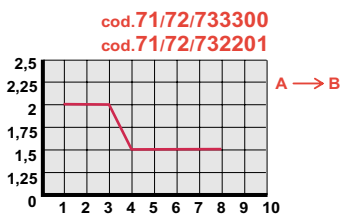
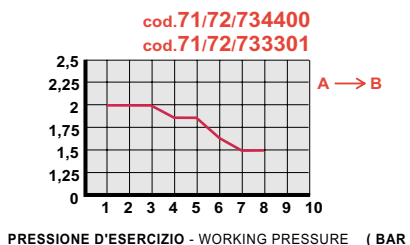
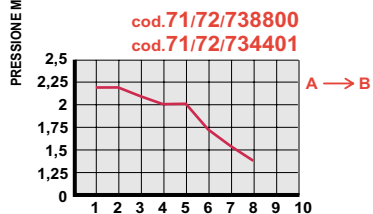
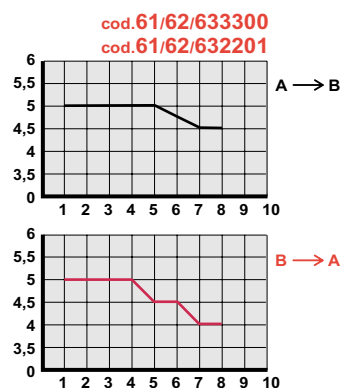
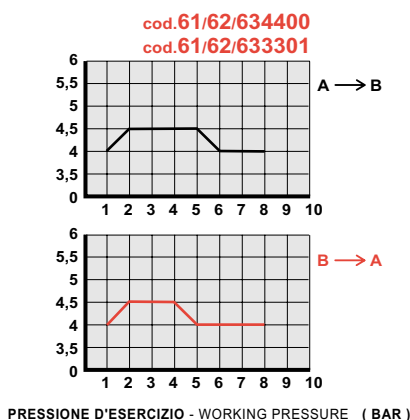
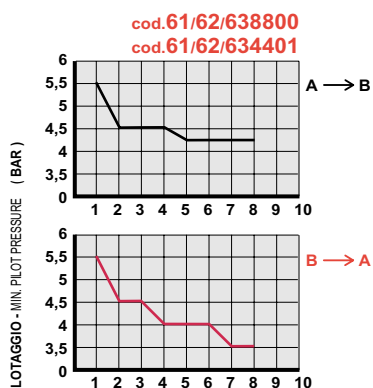
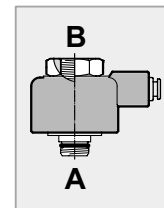

PORTATA MASSIMA IN FUNZIONE DELLA PRESSIONE D'ESERCIZIO

MAX. CAPACITY ACCORDING TO WORKING PRESSURE

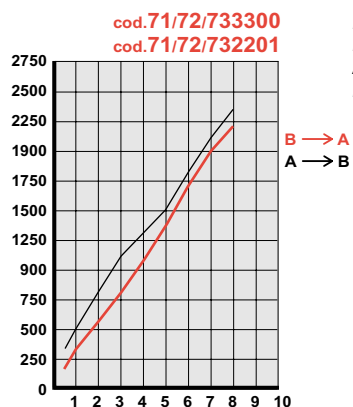
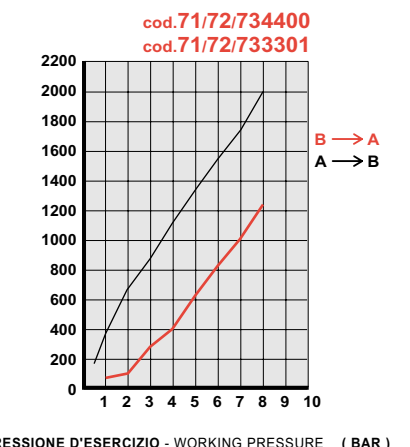
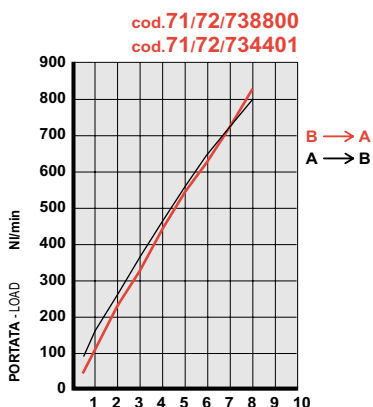
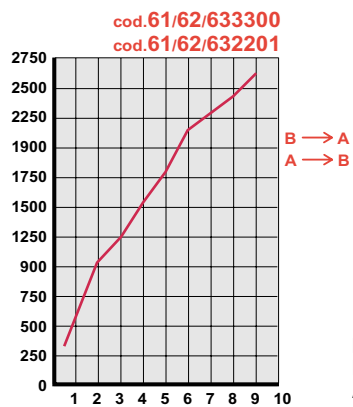
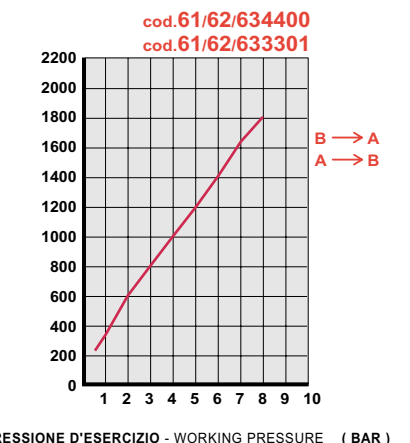
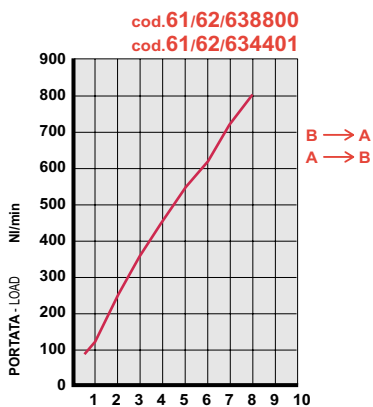
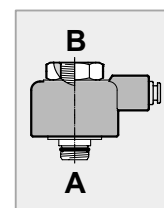

I VALORI DELLA PORTATA MASSIMA SI RIFERISCONO AD UNA PORTATA OTTENUTA CON PRESSIONE ATMOSFERICA A VALLE DELLA VALVOLA

MAX. CAPACITY VALUES REFER TO A CAPACITY WITH ATMOSPHERIC PRESSURE DOWNSTREAM THE VALVE

VALVOLE DI COMPLEMENTO PER CIRCUITI PNEUMATICI

COMPLEMENTARY VALVES FOR PNEUMATIC CIRCUIT

VALVOLE A CORSOIO – SLIDE VALVES

Le valvole a corsoio possono essere considerate valvole di intercettazione ON-OFF.

Nella posizione ON, l'aria proveniente dall'alimentazione viene convogliata verso l'utilizzo.

Spostando il manicotto nella posizione OFF, si esclude il collegamento tra alimentazione e utilizzo dell'aria, scaricando la pressione dell'impianto a valle.

Pressione massima: 10 bar
Temperatura minima: -18°C
Temperatura massima: +70°C

Slide valves can be considered valves of interception ON-OFF.

In ON position, the air that comes from supply is conveyed to the employment.

If you change the position on OFF, you leave out the connection between the supply and the air employment. In this way you unload the pressure to down stream.

Maximum pressure: 10 bar
Minimum temperature: -18°C
Maximum temperature: +70°C

filetto femmina-femmina female-female thread

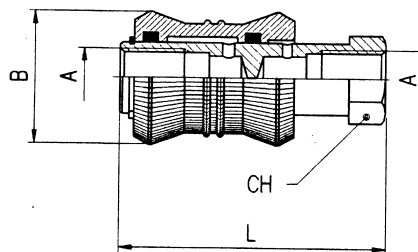

Codice / Code	A	B	L	CH
Al.6060.18	1/8"	25	48	14
Al.6060.14	1/4"	30	58	17
Al.6060.38	3/8"	35	70	22
Al.6060.12	1/2"	40	80	26

filetto maschio-femmina male-female thread

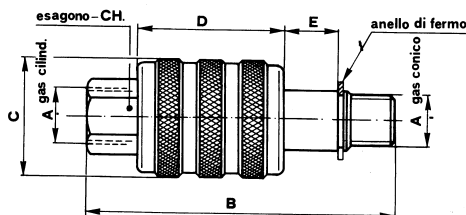

Codice / Code	A	B	C	D	CH	E
MS-8	1/8"	54	25	26	13	8,5
MS-4	1/4"	78	30	37,5	17	12,5
MS-3	3/8"	85	40	42,5	27	14
MS-2	1/2"	85	40	42,5	27	14

VALVOLE DI COMPLEMENTO PER CIRCUITI PNEUMATICI

COMPLEMENTARY VALVES FOR PNEUMATIC CIRCUIT

VALVOLE DI SCARICO RAPIDO

QUICK EXHAUST VALVE

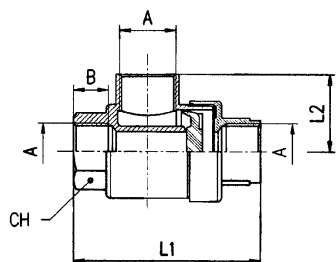
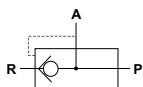

Codice / Code	A	B	L1	L2	CH
VSR 800	1/8"	8,5	42	19,5	15
VSR 400	1/4"	11	54	25	19
VSR 300	3/8"	12	60,5	26,5	22
VSR 200	1/2"	15	72	32	26
VSR 340	3/4"	18,5	88	37	32
VSR 100	1"	19	109	48	46

CARATTERISTICHE TECNICHE

Temperatura: -18°C / +70°C
 Pressione: 0,3 ÷ 10 bar

TECHNICAL FEATURES

Temperature: -18°C / +70°C
 Pressure: 0,3 ÷ 10 bar

VALVOLE UNIDIREZIONALI

NON RETURN VALVES

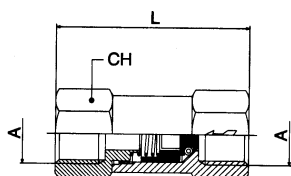

Codice / Code	A	L	CH	Pressione (bar)
6062.M5	M5	26,5	8	2 ÷ 8
VU-8	1/8"	45	17	0,2 ÷ 12
6062.18		35,5	13	2 ÷ 8
VU-4	1/4"	55	21	0,2 ÷ 12
6062.14		43	17	2 ÷ 8
VU-3	3/8"	70	26	0,2 ÷ 12
6062.38		58	24	2 ÷ 8
VU-2	1/2"	85	32	0,2 ÷ 12
6062.12		63	24	2 ÷ 8

VALVOLE DI SICUREZZA

SAFETY VALVES

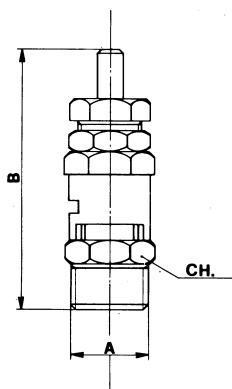

Codice / Code	A	B	CH	Campo di regolazione Adjustment range (bar)
PF.2.8M0206	1/8"	47	14	2 ÷ 6
PF.200M0206	1/4"	47	14	2 ÷ 6
PF.221M0208	3/8"	71	21	2 ÷ 8
PF.222M0208	1/2"	71	21	2 ÷ 8

VALVOLE DI COMPLEMENTO PER CIRCUITI PNEUMATICI

COMPLEMENTARY VALVES FOR PNEUMATIC CIRCUIT

MINI-VALVOLE A SFERA maschio-femmina

MINI BALL VALVE male-female

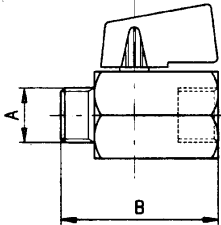

Codice / Code	A	B	Pass. Ø Dn
EF.VS502.18	1/8"	36	5,5
EF.VS502.14	1/4"	36	5,5
EF.VS502.38	3/8"	41	8
EF.VS502.12	1/2"	48	10

MINI-VALVOLE A SFERA femmina-femmina

MINI BALL VALVE female-female

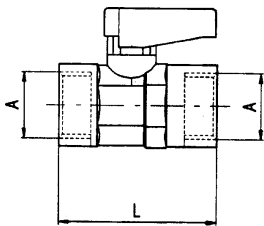

Codice / Code	A	L	Pass. Ø Dn
AI.6400.18	1/8"	35	5,5
AI.6400.14	1/4"	37	5,5
AI.6400.38	3/8"	42	8
AI.6400.12	1/2"	49	10
AI.6920-A-...*	Piastrina colorata: * R= rossa; B= blu; G= gialla; V= verde; W= bianca Coloured plate: * R= red; B= blue; G= yellow; V= green; W= white		

VALVOLE A SFERA femmina-femmina (serie pesante)

BALL VALVE female-female (heavy applications)

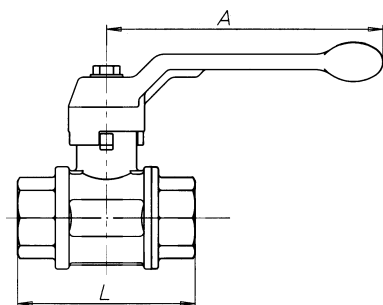

Codice / Code	Size	A	L	Pass. Ø Dn (mm)	Press. Max a 25°C (bar)
EF.VS101.18	1/8"	75	50	8	60
EF.VS101.14	1/4"	75	51	8	60
EF.VS101.38	3/8"	100	55	10	60
EF.VS101.12	1/2"	100	69	15	50
EF.VS101.34	3/4"	120	77	20	50
EF.VS101.1	1"	120	89	25	50
EF.VS101.112	1 1/2"	150	114	40	40
EF.VS101.2	2"	175	134	50	30
EF.VS101.212	2 1/2"	280	160	65	25
EF.VS101.3	3"	280	185	80	20