

VALVOLE ED ELETTROVALVOLE IN ALLUMINIO - serie V-E

ALUMINIUM VALVES AND SOLENOID VALVES - V-E line

1/8" - 1/4" - 1/2"

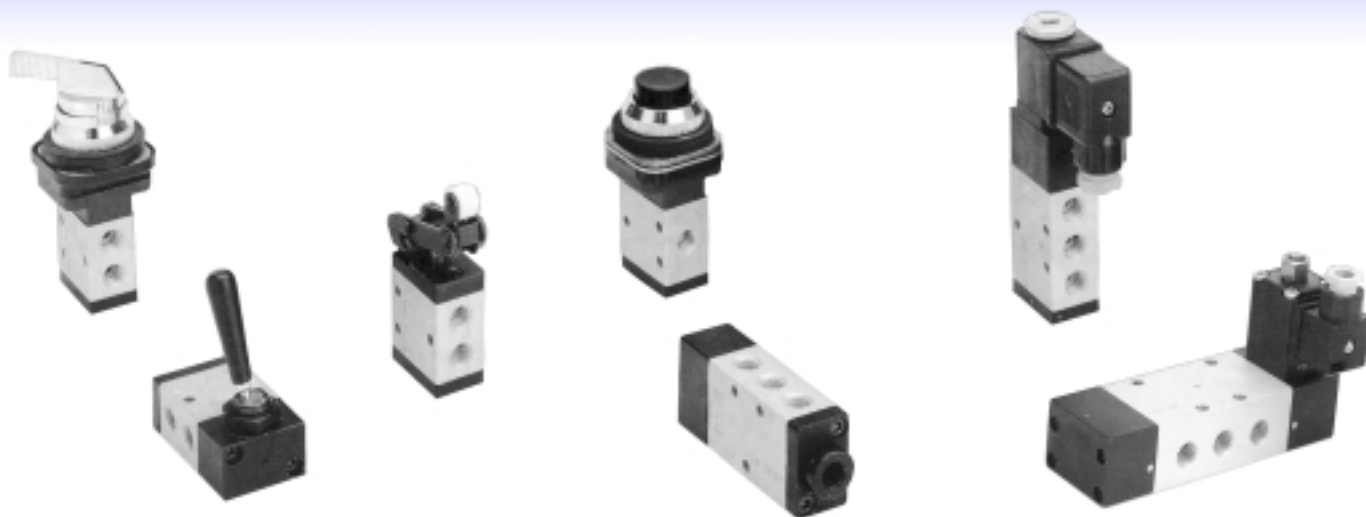

Guida alle referenze

Guide to references

V 4 4 L M CA

Prodotto / Product

V = Valvole pneumatiche
Pneumatic valves
E = Elettrovalvole
Solenoid valves

Funzione / Function

3 = 3 vie
4 = 5 vie

Taglia / Body width

80 = 1/8"
4 = 1/4"
2 = 1/2"

Opzione / Option

CC = Centri chiusi
Closed centres
CA = Centri aperti
Closed centres

Ritorno / Return

M = Molla
Spring
P = Pneumatico
Pneumatic
F = Bistabile
Bistable
S = Solenoide
Solenoid
D = Differenziale
Differential

Azionamento / Operation

L = Leva
Lever
T = Tiretto
Taste
R = Leva rullo
Roller level
S = Leva rullo unidirezionale
Unidirectional roller level
B = Puntale a sfera
Pushrod with ball
C = Puntale a sfera da pannello
Pushrod with ball for panel mounting
P = Pneumatico
Pneumatic

MD = Selettore a leva da pannello
Lever selector for panel mounting
MR = Tasto a fungo da pannello
Axial mushroom for panel mounting
MA = Pulsante protetto da pannello
Protected push button for panel mounting
MC = Pulsante da pannello
Pushrod for panel mounting
MG = Selettore a chiave da pannello
Key selector for panel mounting
MB = Leva assiale da pannello
Axial Lever for panel mounting
S = Solenoide
Solenoid

Le valvole a spola bilanciata della linea **V** e linea **E**, disponibili in 3 differenti taglie 1/8", 1/4", 1/2", sono costruite in lega d'alluminio UNI 3571 e sono completamente ossidate, quindi resistenti alla corrosione. Hanno la caratteristica di avere solo un unico elemento mobile per lo scambio direzionale del flusso, che permette il conseguimento di questi vantaggi:

INTERCAMBIABILITA' dei meccanismi di azionamento e ritorno per ottenere il massimo numero di combinazioni impiegando pochi elementi di base.

STABILITA' DI EQUILIBRIO in ogni posizione poiché l'azione della spola non è influenzata dalla pressione di alimentazione.

LIMITATA MANUTENZIONE poiché le guarnizioni speciali in gomma antiolio sono fisse e lo scorrimento della spola in lega d'alluminio anodizzato con microfinitura superficiale nel loro interno, ne riduce al minimo l'usura. Tutte queste caratteristiche, unitamente alla prontezza di intervento ed alla grande portata consente a queste valvole prestazioni del tutto eccezionali ed un funzionamento preciso e continuo per milioni di azionamenti. Si consiglia l'uso di filtri o silenziatori montati sugli scarichi onde evitare l'entrata, all'interno della valvola, di polvere o corpi estranei che ne danneggerebbero irrimediabilmente il funzionamento.

Line V and E includes balanced spool valves, available in 3 different sizes 1/8", 1/4", 1/2", which are built on aluminium UNI 3571 and are totally oxidate, than proof against the corrosion. They have only one moving element for the executive change of the flow, that allows this advantages:

INTERCHANGEABILITY of driving gear and return to have the greatest number of combination with little elements.

BALANCE STABILITY i every position because spool's action is not influenced from the pressure of the input.

NARROW MAINTENANCE because the special gaskets on antioil rubber are fixed and the running of aluminium spool, anodized with superficial precision finishing inside, reduce the wear. All this characteristics, the response time, the big flow rate allow exceptional performance and anhigh operating frequency. We advise the use of filter or silencer that are assembled on the discharged to avoid the entry of the dust or other strange bodys that would damage the working.

Dati Tecnici

Costruzione: Valvola a spola, 3/2 - 5/2 - 5/3
Fluido: Aria filtrata e lubrificata
Pressione max: 10 bar
Tipo di connessione: G1/8" - G1/4" - G1/2"
Range di temperatura: -30°C / +120°C

Technical data

Construction: 3/2 - 5/2 - 5/3 spool valve
Fluid: Filtered and lubricated air
Maximum pressure: 10 bar
Connection type: G1/8" - G1/4" - G1/2"
Temperature range: -30°C / +120°C

FLUIDO SISTEM S.r.l.

Via Nicomede Bianchi, 61/3 - 10146 TORINO (Italy)
Tel. +39 011.797.322 - 011.797.420 / Fax +39 011.797.412
E-mail: fluidosistem@mclink.it - Web: www.fluidosistem.it

VALVOLE ED ELETTROVALVOLE IN ALLUMINIO - serie V-E

ALUMINIUM VALVES AND SOLENOID VALVES - V-E line

Dati Tecnici

Tipo di connessione: G1/8"
 Sezione utile: 19,63 mm²
 Pressione max: 10 bar
 Range di temperatura: -10°C +80°C

Technical data

Connection size: G1/8"
 Usable section: 19,63 mm²
 Maximum pressure: 10 bar
 Temperature range: -10°C +80°C

Codici di ordinazione

Order codes

	CODE	REFERENCE
	V380PM	Pneumatico-molla / <i>Pneumatic-spring</i>
	V480PM	Pneumatico-molla / <i>Pneumatic-spring</i>

Valvole pneumatiche monostabili
Monostable pneumatic valves

1/8"

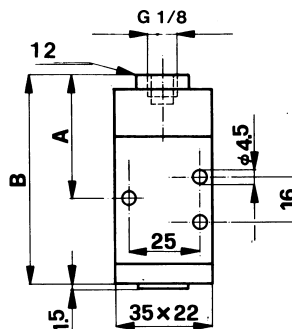

Code	Type	Press. d'azionamento <i>Operation's pressure</i>	A	B
V 380 PM	3/2	1,1 bar	41	64
V 480 PM	5/2	2 bar	49	80

Dati Tecnici

Tipo di connessione: G1/8"
 Sezione utile: 19,63 mm²
 Pressione max: 10 bar
 Range di temperatura: -10°C +80°C

Technical data

Connection size: G1/8"
 Usable section: 19,63 mm²
 Maximum pressure: 10 bar
 Temperature range: -10°C +80°C

Codici di ordinazione

Order codes

	CODE	REFERENCE
	V380PD	Pneumatico-differenziale <i>Pneumatic-differential</i>
	V480PD	Pneumatico-differenziale <i>Pneumatic-differential</i>
	V380PP	Pneumatico-pneumatico <i>Pneumatic-pneumatic</i>
	V480PP	Pneumatico-pneumatico <i>Pneumatic-pneumatic</i>

Valvole pneumatiche bistabili
Bistable pneumatic valves

1/8"

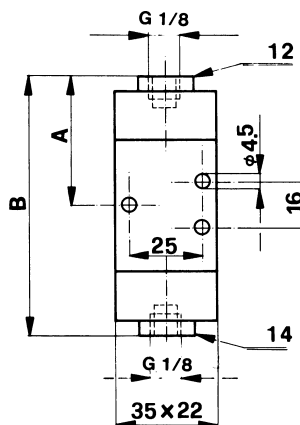

Code	Type	Press. d'azionamento <i>Operation's pressure</i>	A	B
V 380 PD	3/2	2 bar	49	85
V 380 PP	3/2	1,3 bar	41	82
V 480 PD	5/2	2,2 bar	49	85
V 480 PP	5/2	1,4 bar	49	98
N.B. 14-12 fori di pilotaggio. Per il ritorno differenziale il 14 va tenuto in pressione 14-12 pilot's hole. For the differential, to keep up pressure on the 14				

VALVOLE ED ELETTROVALVOLE IN ALLUMINIO - serie V-E

ALUMINIUM VALVES AND SOLENOID VALVES - V-E line

Dati Tecnici

Tipo di connessione: G1/8"
 Sezione utile: 19,63 mm²
 Pressione max: 10 bar
 Range di temperatura: -10°C +90°C
 Tipo di azionamento manuale: bistabile
 Tensione: 24V DC, 24V AC, 110V AC, 220V AC
 Grado di protezione con connettore: IP 65
 LA BOBINA VIENE FORNITA SEPARATAMENTE

Elettrovalvole monostabili
 Monostable solenoid valve

1/8"

Technical data

Connection size: G1/8"
 Usable section: 19,63 mm²
 Maximum pressure: 10 bar
 Temperature range: -10°C +90°C
 Manual override: bistable
 Voltage: 24V DC, 24V AC, 110V AC, 220V AC
 Protection whit connector: IP 65
 COIL IS SUPPLIED SEPARATELY

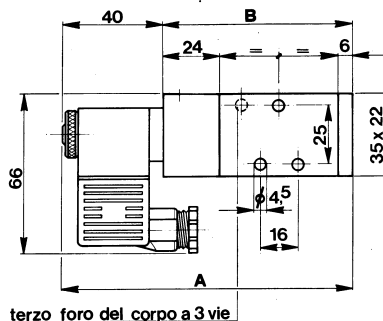

Codici di ordinazione

Order codes

CODE	REFERENCE
 E380SD	Solenoide-differenziale Solenoid-differential
 E480SD	Solenoide-differenziale Solenoid-differential

Code	Type	Min. pressione di funzionamento Minimum operating pressure	A	B
E 380 SD	3/2	2 bar	104	64
E 480 SD	5/2	2 bar	120	80

Dati Tecnici

Tipo di connessione: G1/8"
 Sezione utile: 19,63 mm²
 Pressione max: 10 bar
 Range di temperatura: -10°C +90°C
 Tipo di azionamento manuale: bistabile
 Tensione: 24V DC, 24V AC, 110V AC, 220V AC
 Grado di protezione con connettore: IP 65
 LE BOBINE VENGONO FORNITE SEPARATAMENTE

Elettrovalvole bistabili
 Bistable solenoid valves

1/8"

Technical data

Connection size: G1/8"
 Usable section: 19,63 mm²
 Maximum pressure: 10 bar
 Temperature range: -10°C +90°C
 Manual override: bistable
 Voltage: 24V DC, 24V AC, 110V AC, 220V AC
 Protection whit connector: IP 65
 COILS ARE SUPPLIED SEPARATELY

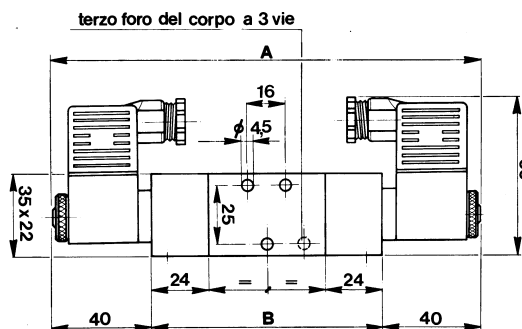

Codici di ordinazione

Order codes

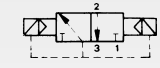
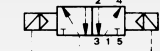
CODE	REFERENCE
 E380SS	Solenoide-solenoide Solenoid-solenoid
 E480SS	Solenoide-solenoide Solenoid-solenoid

Code	Type	Min. pressione di funzionamento Minimum operating pressure	A	B
E 380 SS	3/2	1,5 bar	162	82
E 480 SS	5/2	1,5 bar	178	98

VALVOLE ED ELETTROVALVOLE IN ALLUMINIO - serie V-E

ALUMINIUM VALVES AND SOLENOID VALVES - V-E line

Dati Tecnici

Tipo di connessione: G1/4"
 Sezione utile: 50.3 mm²
 Pressione max: 10 bar
 Range di temperatura: -30°C +120°C

Technical data

Connection size: G1/4"
 Usable section: 50.3 mm²
 Maximum pressure: 10 bar
 Temperature range: -30°C +120°C

Codici di ordinazione

Order codes

CODE REFERENCE



V34PM Pneumatico-molla / *Pneumatic-spring*



V44PM Pneumatico-molla / *Pneumatic-spring*

Valvole pneumatiche monostabili

Monostable pneumatic valves

1/4"

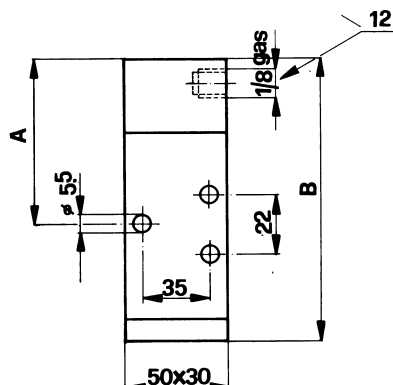

Code	Type	Forza d'azionamento <i>Operation's force</i>	A	B
V 34 PM	3/2	2,4 bar	59	96
V 44 PM	5/2	2,4 bar	70	118

Dati Tecnici

Tipo di connessione: G1/4"
 Sezione utile: 50.3 mm²
 Pressione max: 10 bar
 Range di temperatura: -30°C +120°C

Technical data

Connection size: G1/4"
 Usable section: 50.3 mm²
 Maximum pressure: 10 bar
 Temperature range: -30°C +120°C

Codici di ordinazione

Order codes

CODE REFERENCE



V34PD Pneumatico-differenziale
Pneumatic-differential



V44PD Pneumatico-differenziale
Pneumatic-differential

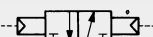

V34PP Pneumatico-pneumatico
Pneumatic-pneumatic



V44PP Pneumatico-pneumatico
Pneumatic-pneumatic



V44CA Centri aperti
Opened centres



V44CC Centri chiusi
Closed centres

Valvole pneumatiche bistabili

Bistable pneumatic valves

1/4"

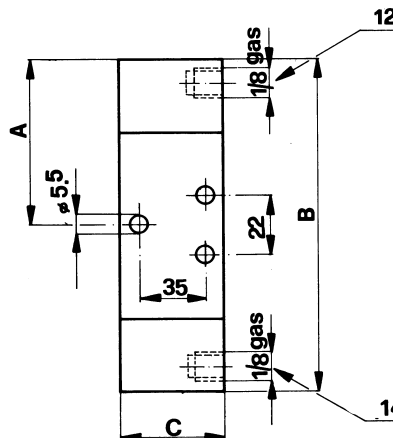

Code	Type	Forza d'azionamento <i>Operation's force</i>	A	B	C
V 34 PD	3/2	2 bar	59	118	30
V 34 PP	3/2	0,9 bar	59	118	30
V 44 PD	5/2	2 bar	70	140	30
V 44 PP	5/2	1 bar	70	140	30
V 44 CA	5/3	3 bar	-	150	35
V 44 CC	5/3	3 bar	-	150	35

N.B. 14-12 fori di pilotaggio. Per il ritorno differenziale il 14 va tenuto in pressione
 14-12 pilot's hole. For the differential, to keep up pressure on the 14

VALVOLE ED ELETTROVALVOLE IN ALLUMINIO - serie V-E

ALUMINIUM VALVES AND SOLENOID VALVES - V-E line

Dati Tecnici

Tipo di connessione: G1/4"
 Sezione utile: 56,74 mm²
 Pressione max: 10 bar
 Range di temperatura: -10°C +90°C
 Tipo di azionamento manuale: bistabile
 Tensione: 24V DC, 24V AC, 110V AC, 220V AC
 Grado di protezione con connettore: IP 65
 LA BOBINA VIENE FORNITA SEPARATAMENTE

Technical data

Connection size: G1/4"
 Usable section: 56 mm²
 Maximum pressure: 10 bar
 Temperature range: -10°C +90°C
 Manual override: bistable
 Voltage: 24V DC, 24V AC, 110V AC, 220V AC
 Protection whit connector: IP 65
 COIL IS SUPPLIED SEPARATELY

Codici di ordinazione

Order codes

CODE	REFERENCE
 E34SD	Solenoide-differenziale Solenoid-differential
 V44SD	Solenoide-differenziale Solenoid-differential

Elettrovalvole monostabili

Monostable solenoid valves

1/4"

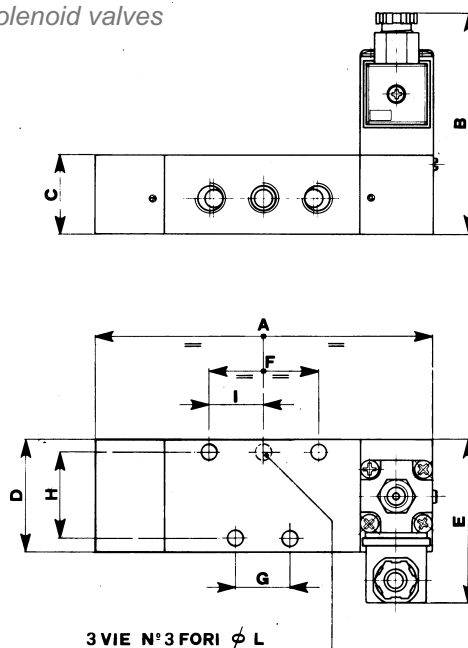

Code	Type	Min. pressione di funzionamento Min. operating pressure	A	B	C	D	E	F	G	H	I	L
E 34 SD	3/2	2,5 bar	120	97	35	50	71	-	-	38	22	5,5
E 44 SD	5/2	2,5 bar	148	97	35	50	71	47	22	38	-	6,5

Dati Tecnici



Tipo di connessione: G1/4"
 Sezione utile: 56,74 mm²
 Pressione max: 10 bar
 Range di temperatura: -10°C +90°C
 Tipo di azionamento manuale: bistabile
 Tensione: 24V DC, 24V AC, 110V AC, 220V AC
 Grado di protezione con connettore: IP 65
 LE BOBINE VENGONO FORNITE SEPARATAMENTE

Technical data

Connection size: G1/4"
 Usable section: 56,74 mm²
 Maximum pressure: 10 bar
 Temperature range: -10°C +90°C
 Manual override: bistable
 Voltage: 24V DC, 24V AC, 110V AC, 220V AC
 Protection whit connector: IP 65
 COILS ARE SUPPLIED SEPARATELY

Codici di ordinazione

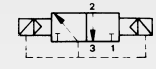
Order codes

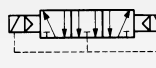
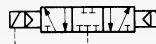
CODE	REFERENCE
 E34SS	Solenoide-solenoide Solenoid-solenoid
 E44SS	Solenoide-solenoide Solenoid-solenoid
 E44CA	Centri aperti Opened centres
 E44CC	Centri chiusi Closed centres

Elettrovalvole bistabili

Bistable solenoid valves

1/4"

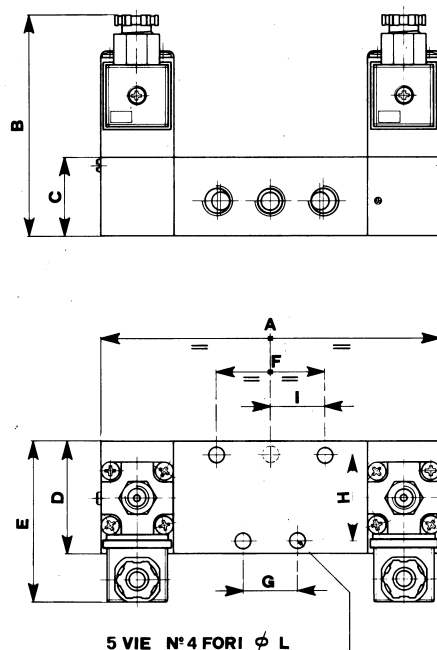

Code	Type	Min. pressione di funzionamento Min. operating pressure	A	B	C	D	E	F	G	H	I	L
E 34 SS	3/2	2 bar	122	97	35	50	71	-	-	38	22	6,5
E 44 SS	5/2	2 bar	150	97	35	50	71	47	22	38	--	6,5
E 44 CA	5/3	3,5 bar	150	97	35	50	71	47	22	38	--	6,5
E 44 CC	5/3	3,5 bar	150	97	35	50	71	47	22	38	-	6,5

VALVOLE ED ELETTROVALVOLE IN ALLUMINIO - serie V-E

ALUMINIUM VALVES AND SOLENOID VALVES - V-E line

Dati Tecnici

Tipo di connessione: G1/2"
 Sezione utile: 183 mm²
 Pressione max: 10 bar
 Range di temperatura: -30°C +120°C

Technical data

Connection size: G1/2"
 Usable section: 183 mm²
 Maximum pressure: 10 bar
 Temperature range: -30°C +120°C

Codici di ordinazione

Order codes

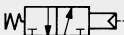
CODE	REFERENCE
 V32PM	Pneumatico-molla / <i>Pneumatic-spring</i>

 V42PM	Pneumatico-molla / <i>Pneumatic-spring</i>
--	--

Valvole pneumatiche monostabili

Monostable pneumatic valves

1/2"

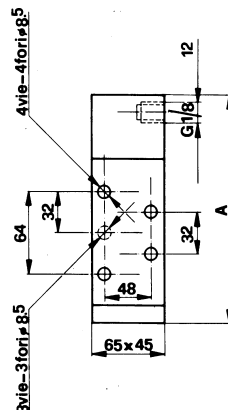

Code	Type	Press. d'azionamento <i>Operation's pressure</i>	A
V 32 PM	3/2	1,2 bar	128,5
V 42 PM	5/2	1,2 bar	160,5

Dati Tecnici

Tipo di connessione: G1/2"
 Sezione utile: 183 mm²
 Pressione max: 10 bar
 Range di temperatura: -30°C +120°C

Technical data

Connection size: G1/2"
 Usable section: 183 mm²
 Maximum pressure: 10 bar
 Temperature range: -30°C +120°C

Codici di ordinazione

Order codes

CODE	REFERENCE
 V32PD	Pneumatico-differenziale <i>Pneumatic-differential</i>

 V42PD	Pneumatico-differenziale <i>Pneumatic-differential</i>
--	---

 V32PP	Pneumatico-pneumatico <i>Pneumatic-pneumatic</i>
--	---

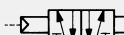
 V42PP	Pneumatico-pneumatico <i>Pneumatic-pneumatic</i>
--	---

 V42CA	Centri aperti <i>Opened centres</i>
--	--

 V42CC	Centri chiusi <i>Closed centres</i>
--	--

Valvole pneumatiche bistabili

Bistable pneumatic valves

1/2"

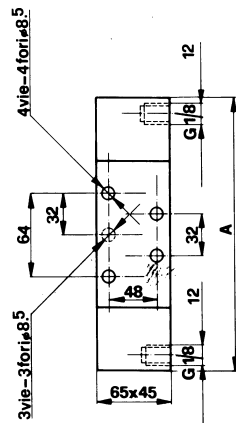

Code	Type	Press. d'azionamento <i>Operation's pressure</i>	A
V 32 PD	3/2	2,2 bar	141
V 32 PP	3/2	0,9 bar	141
V 42 PD	5/2	2,2 bar	173
V 42 PP	5/2	1 bar	173
V 42 CA	5/3	2,6 bar	173
V 42 CC	5/3	2,6 bar	173

N.B. 14-12 fori di pilotaggio. Per il ritorno differenziale il 14 va tenuto in pressione
 14-12 pilot's hole. For the differential, to keep up pressure on the 14

VALVOLE ED ELETTROVALVOLE IN ALLUMINIO - serie V-E

ALUMINIUM VALVES AND SOLENOID VALVES - V-E line

Dati Tecnici

Tipo di connessione: G1/2"
 Sezione utile: 183 mm²
 Pressione max: 10 bar
 Range di temperatura: -10°C +90°C
 Tipo di azionamento manuale: bistabile
 Tensione: 24V DC, 24V AC, 110V AC, 220V AC
 Grado di protezione con connettore: IP 65
 LA BOBINA VIENE FORNITA SEPARATAMENTE

Technical data

Connection size: G1/2"
 Usable section: 183 mm²
 Maximum pressure: 10 bar
 Temperature range: -10°C +90°C
 Manual override: bistable
 Voltage: 24V DC, 24V AC, 110V AC, 220V AC
 Protection whit connector: IP 65
 COIL IS SUPPLIED SEPARATELY

Codici di ordinazione

Order codes

	CODE	REFERENCE
	E32SD	Solenoide-differenziale Solenoid-differential
	V42SD	Solenoide-differenziale Solenoid-differential

Elettrovalvole monostabili

Monostable solenoid valves

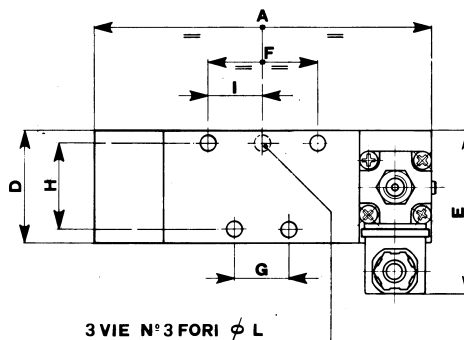
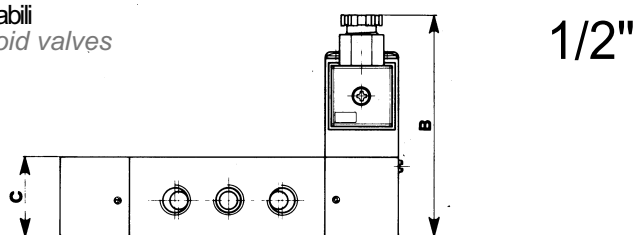

Code	Type	Min. pressione di funzionamento Min. operating pressure	A	B	C	D	E	F	G	H	I	L
E 32 SD	3/2	2 bar	141	107	45	65	78,5	-	-	48	32	8,5
E 42 SD	5/2	2 bar	173	107	45	65	78,5	64	32	48	-	8,5

Dati Tecnici

Tipo di connessione: G1/2"
 Sezione utile: 183 mm²
 Pressione max: 10 bar
 Range di temperatura: -10°C +90°C
 Tipo di azionamento manuale: bistabile
 Tensione: 24V DC, 24V AC, 110V AC, 220V AC
 Grado di protezione con connettore: IP 65
 LE BOBINE VENGONO FORNITE SEPARATAMENTE

Technical data

Connection size: G1/2"
 Usable section: 183 mm²
 Maximum pressure: 10 bar
 Temperature range: -10°C +90°C
 Manual override: bistable
 Voltage: 24V DC, 24V AC, 110V AC, 220V AC
 Protection whit connector: IP 65
 COILS ARE SUPPLIED SEPARATELY

Codici di ordinazione

Order codes

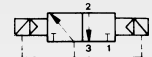
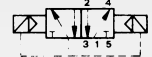
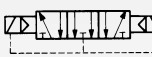
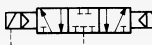
	CODE	REFERENCE
	E32SS	Solenoide-solenoide Solenoid-solenoid
	E42SS	Solenoide-solenoide Solenoid-solenoid
	E42CA	Centri aperti Opened centres
	E42CC	Centri chiusi Closed centres

Elettrovalvole bistabili

Bistable solenoid valves

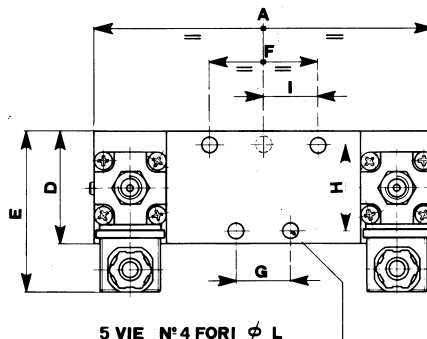
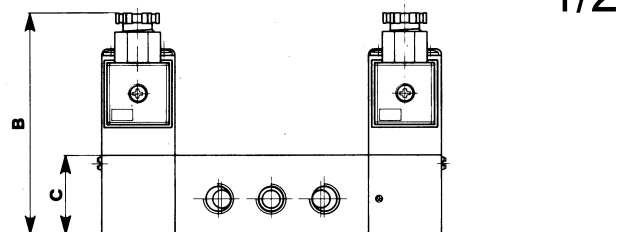

Code	Type	Min. pressione di funzionamento Min. operating pressure	A	B	C	D	E	F	G	H	I	L
E 32 SS	3/2	1,5 bar	141	107	45	65	78,5	-	-	48	32	8,5
E 42 SS	5/2	1,5 bar	173	107	45	65	78,5	64	32	48	-	8,5
E 42 CA	5/3	3,5 bar	193	107	45	65	78,5	64	32	48	-	8,5
E 42 CC	5/3	3,5 bar	193	107	45	65	78,5	64	32	48	-	8,5